

Varenummer: 40550400611225
 Beskrivelse: Tandhjulsgear S401P-6,1-P71B5

Mål

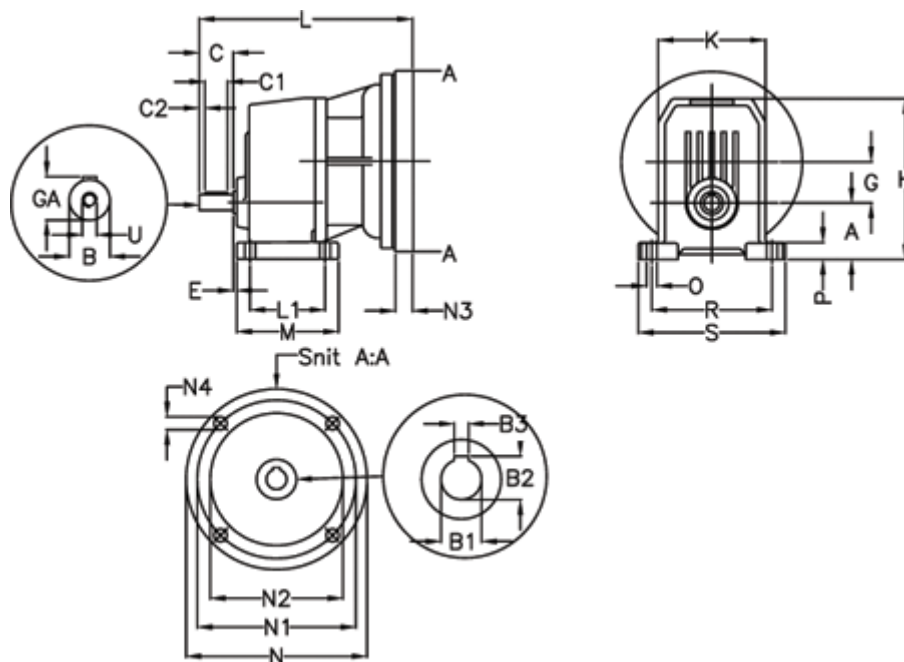

A = 70	E = 23.0	M = 165.0	R = 180
B = 28	F = 8x7x50	N = 160	S = 215
B1 = 14	G = 61.7	N1 = 130	U = M8
B2 = 16.3	GA = 31.0	N2 = 110	
B3 = 5	H = 224.5	N3 = -	
C = 60	K = 155	N4 = M10x12	
C1 = 50	L = 294	O = 14	
C2 = 5	L1 = 125.0	P = 21.0	